

front

back

PHILIPS

Zarpy

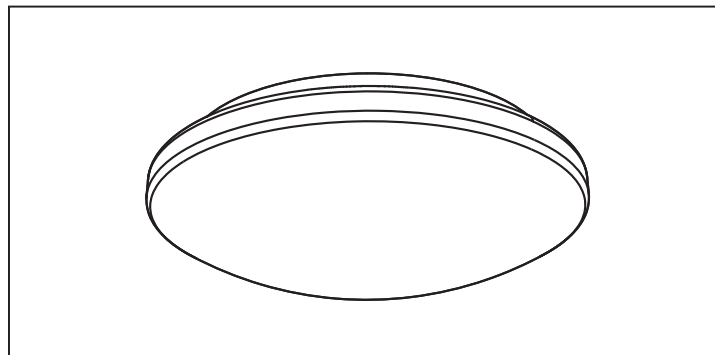
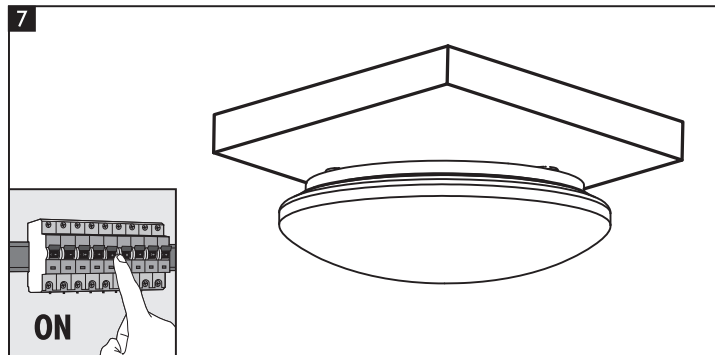
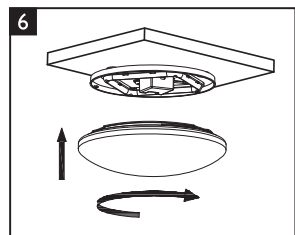
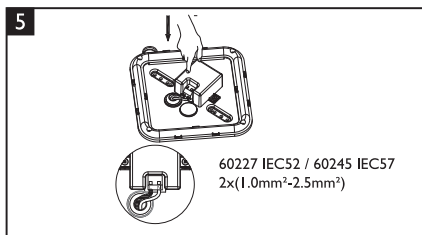
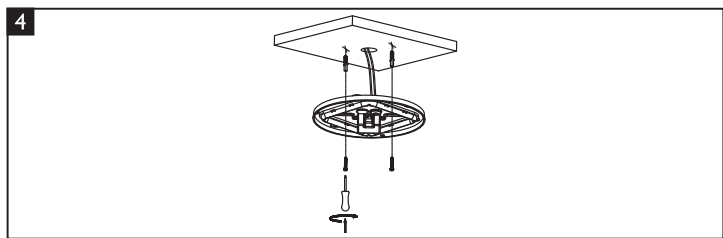
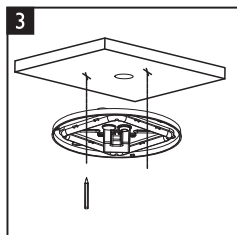
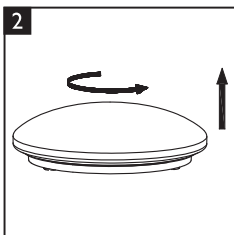
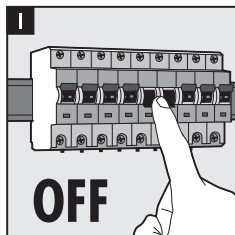
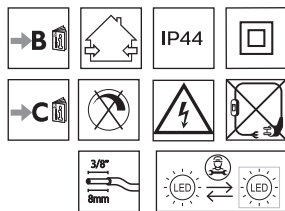

E 9290022094 9290022095

Philips and the Philips shield emblem are registered trademarks of Koninklijke Philips N.V.

Signify
I.B.R.S. / C.C.R.I. Numéro 10461
5600 VB Eindhoven, the Netherlands
www.philips.com/lighting

© 2021 Signify Holding

©ignify

Signify Commercial UK Limited
Unit 3, Guildford Business Park,
Guildford, Surrey, GU2 8XG, UK



3241 653 91704

Last update: 12/04/21

size: 105mmx148mm